

DEVELOPMENT OF A PNEUMATIC SCREW CONVEYOR DESIGN AND SUBSTANTIATION OF ITS PARAMETERS

/ РОЗРОБКА КОНСТРУКЦІЇ ПНЕВМО-ШНЕКОВОГО ТРАНСПОРТЕРА ТА ОБГРУНТУВАННЯ ЙОГО ПАРАМЕТРІВ

Prof. Ph.D. Eng. Hevko R.B.¹⁾, Prof. Ph.D. Eng. Strishenets O.M.²⁾, Prof. Ph.D. Eng. Lyashuk O.L.³⁾,
Assoc. Prof. Ph.D. Eng. Tkachenko I.G.³⁾, Assoc. Ph.D. Eng. Klendii O.M.⁴⁾, Assoc. Prof. Ph.D. Eng. Dzyura V.O.³⁾,

¹⁾Ternopil National Economical University / Ukraine; ²⁾Lesya Ukrainka Eastern European National University / Ukraine;

³⁾Ternopil Ivan Puluj National Technical University / Ukraine; ⁴⁾Separated Subdivision of National University of Life and Environmental Sciences of Ukraine Berezhanly Agrotechnical Institute / Ukraine;

E-mail: sashaklendii@gmail.com

Keywords: *pneumatic screw conveyor, loose material, screw feeder, air pressure.*

ABSTRACT

The paper presents the developed design of a research prototype of a pneumatic screw conveyor and the research methodology aimed at determining power characteristics for moving various types of loose materials depending on the influence of pressure and air volume. The dependences of pneumatic screw conveyor efficiency on the change in the area of a hopper hole, the rotation frequency of a screw feeder and the value of an operating air pressure in a technological line have been determined. The influence of the form and the geometrical parameters of a central replaceable nozzle on the distance of loose materials transportation has been determined.

РЕЗЮМЕ

В статті представлено розроблену конструкцію дослідного збірця пневмо-шнекового транспортера та методу проведення досліджень для визначення силових показників переміщення різних типів сипких матеріалів в залежності від впливу тиску та об'єму повітря. Встановлено залежності продуктивності пневмо-шнекового транспортера від зміни площі отвору бункера, частоти обертання шнекового живильника та величини робочого тиску повітря в технологічній магістралі. Встановлено вплив форми та геометричних параметрів центрального змінного сопла на відстань транспортування сипких матеріалів.

INTRODUCTION

The conducted analysis of recent scientific and patent literature (Lyashuk O.L. et al., 2015; Rogatynska O. et al., 2015; Loveikin V. and Rogatynska L., 2011; Lech M., 2001; Manjula E.V.P.J. et al., 2017; Naveen Tripathi, 2015), which covers the design of operating devices and the ways of loose material transportation in closed casings along both rectilinear and curvilinear routs, shows that they satisfy most of the requirements for the process quality to a certain extent. But the issues connected to the improvement of conveyor efficiency, the reliability of operating elements, the reduction of energy consumption and minimization of loose material damage during its transportation etc. have not been fully investigated yet. This paper presents further investigation of the issues, covered in paper (Hevko R.B. et al., 2014; Hevko R.B. et al., 2016; Hevko R.B. et al., 2017).

MATERIALS AND METHODS

In order to conduct experimental investigations, a research prototype of a pneumatic screw conveyor (Fig. 1) has been designed and developed. It contains a frame 1, where there is an electric motor 2, which is connected to a V-belt drive 3 with a reducer 4. With the help of a chain drive 5, a take-off shaft of a reducer transmits torque to the shaft of a screw feeder 6. Loose material is loaded into a hopper 7. A centre shaft of a screw feeder is connected to a pneumatic system with the help of pneumatic pipelines 8. A splined shaft of a screw feeder is arranged with the possibility of angular displacement in bearing assemblies and is spring biased 9. Pressure of the compressed air is delivered through a pneumatic transmitter 10 to a pneumatic distributor 11 in the central opening of a screw feeder, where there is a replaceable nozzle 12 arranged.

Loose material comes through a hopper into a conveyor body and gets onto a screw feeder, which carries out a rotational motion. If there is an overload, which is caused by the accumulation of a certain amount of loose material in the process chamber of the conveyor body, due to its spiral surface a screw feeder is axially displaced in the direction opposite to the one of loose material transportation with the help of a splined joint and it compresses a spring. Here, air from the pneumatic distributor reaches the central opening of the screw feeder splined shaft, which causes further transportation of loose material.

At the first stage of the experimental research, actual efficiency of a pilot plant without air feed has been defined and initial escape of material transportation or steady provision of accelerated material transportation after its rolling off the flights have been determined.

In order to determine the influence of the hopper discharge hole area and screw rotation frequency on the efficiency of a pilot plant, investigations without high-pressure air feed were conducted based on the implementation of a multi-factor experiment, and searching experiments were conducted based on the implementation of a single-factor classical experiments.

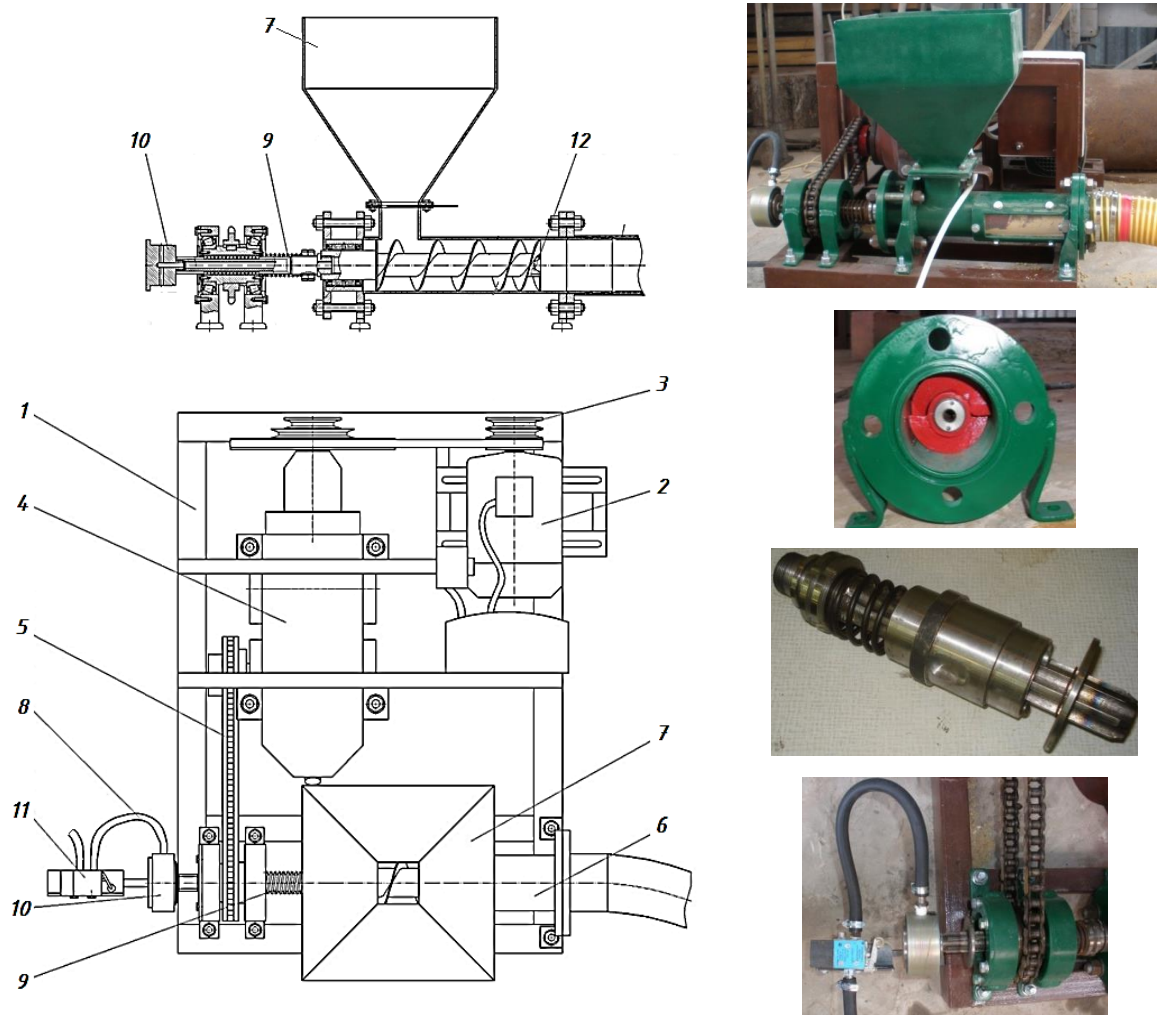

Fig. 1 - Pneumatic Screw Conveyor:

1 – frame; 2 – electric motor; 3 – V-belt drive; 4 – gear box; 5 – chain drive; 6 – feeder housing; 7 – hopper; 8 – pneumatic pipelines; 9 – spring; 10 – pneumatic adapter; 11 – pneumatic distributor; 12 – interchangeable nozzle

A response function or an optimization parameter of a pilot plant efficiency Q_1^e without high-pressure air feed, which was determined by an experimental approach, was found in the form of a mathematical model of a logarithmic function

$$Q_1^e = b_0 + b_1 \ln x_1 + b_2 \ln x_2 \tag{1}$$

where Q_1^e – efficiency of a pilot plant without high-pressure air feed, kg/m; b_0, b_1, b_2 – coefficients of an

approximate model under orthogonality and symmetry conditions; having made calculations, it has been determined that $b_0 = -27.49$; $b_1 = 5.2$; $b_2 = 2.77$; coded factors according to the area of a hopper discharge hole: $x_1 - S_c \times 10^{-4}, m^2$; frequency of screw rotation: $x_2 - n, rev/m$.

According to the results of the conducted multi-factor experiment, the general view of the regression equation of the dependence of the pilot plant efficiency Q_1^e without high-pressure air feed on the hopper discharge hole area S_c and the screw rotation frequency n in actual values is the following:

$$Q_1^e = -27.49 + 5.2 \ln(S_c) + 2.77 \ln(n) \tag{2}$$

During the performance of the experiments, the factorial field was determined by the following parameter range: $12 \leq S_c \leq 35 (10^{-4} m^2)$; $150 \leq n \leq 450 (rev/m)$.

The obtained regression equation (2) can be used for determining the efficiency of a pilot plant Q_1^e without high-pressure air feed according to the area of a hopper discharge hole S_c and the frequency of screw rotation n .

Based on the regression dependences, a response surface with its two-dimensional section of the change in the efficiency of a pilot plant without high-pressure air feed as a functional $Q_1^e = f(S_c, n)$ was constructed, which is represented in Fig. 2.

The pattern of Q_1^e change shows that within the limits of factor variation, the efficiency changes from 0.75 to 9.0 (kg/m). Here, the pattern of Q_1^e changes depending on each separate factor is different: the rate of Q_1^e gain depending on the change in the hopper discharge hole area S_c is much bigger than the rate of efficiency gain depending on screw rotation frequency n and is within the limits of 0.5...2.5 kg/m and 3.5...7.0 kg/m respectively. Thus, the S_c influence on the plant efficiency is much bigger than the one of screw rotation frequency n .

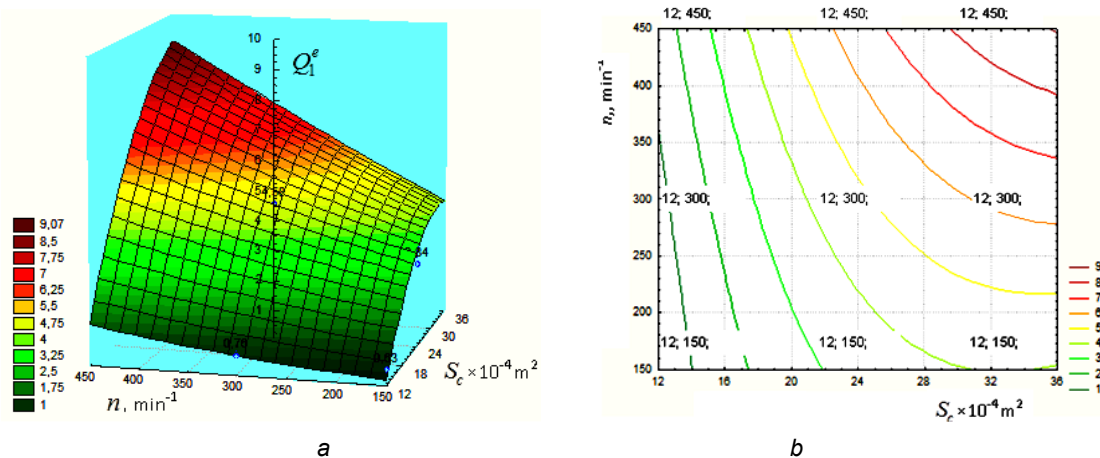

Fig. 2. - Response surface (a) and its two-dimensional section (b) of the change in pilot plant efficiency depending on the hopper discharge hole area S_c and the screw rotation frequency n

The determination of the lower value of air feed operating pressure P , at which the beginning of material acceleration (its rolling off) at the discharge end of a flight can be observed, was carried out by means of implementing searching experiments, which were conducted at constant minimum values of the factors $S_c = 12 \cdot 10^{-4} m^2$ and $n = 150 rev/m$.

In order to conduct comparative studies with high pressure air feed P at the take-off shaft of a screw feeder, nozzles of various configurations were made (Fig. 3). When determining maximum distance of free material movement from a nozzle, investigations were conducted at the constant frequency of feeder rotation $n = 450 rev/m$ and air feed pressure $0.8 \cdot 10^6 N/m^2$.

The necessity of conducting searching experiments was based on the fact that a pilot plant is a scaled model, the dimensional specifications of which significantly differ from those of a full-scale pneumatic screw conveyor. The beginning of accelerated material movement was visually observed with the help of screening and comparing high-speed shooting (Fig. 4) at the initial value of $P = 0.05 \cdot 10^6 N/m^2$ and the following level of operating pressure variation $\Delta P = 0.02 \cdot 10^6 N/m^2$.

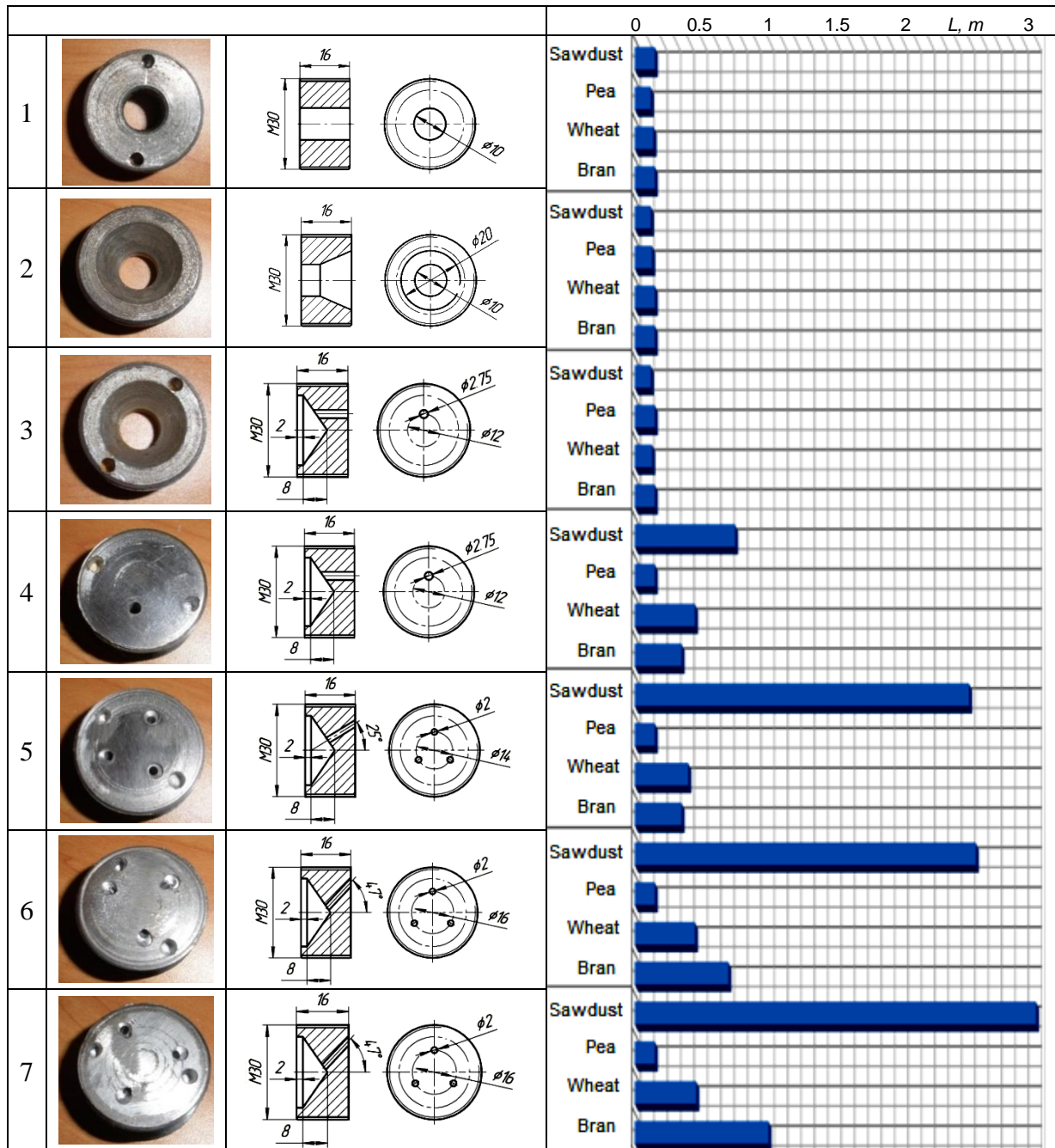

Fig. 3 - The distance of loose material transportation depending on the form and the geometrical parameters of a pneumatic screw conveyor nozzle:

1, 2, 3 – with a central opening of various conicity (diameter $D = 10$ mm); 4, – with a non-central opening (diameter $D = 2.75$ mm); 5, 6, 7 – with three openings located at various angles to the axis



Fig. 4 - General view of high-speed shooting of material movement acceleration process

RESULTS

The results of the experimental investigations on the change in pneumatic screw conveyor efficiency depending on the initial values of high pressure air feed P are represented by a graphic chart (Fig. 5).

It has been determined that the change of the operating pressure P within the limits of $(0.05...0.2) \cdot 10^6$ N/m² has almost no influence on the pneumatic screw conveyor efficiency and material movement acceleration is observed at $P_{\min} \approx 0.2 \cdot 10^6$ N/m².

Experimental investigations of the pilot plant efficiency at high pressure air feed were conducted based on the implementation of a multi-factor experiment (three-factor experiment at the levels of variation).

The procedure of planning and conducting experiments and the processing of the obtained experimental data is similar to the previous one, except for the fact that together with engaging the drive of the screw, a compressor unit was simultaneously turned on as well, having the preset necessary value of the operating air pressure P entering the collector.

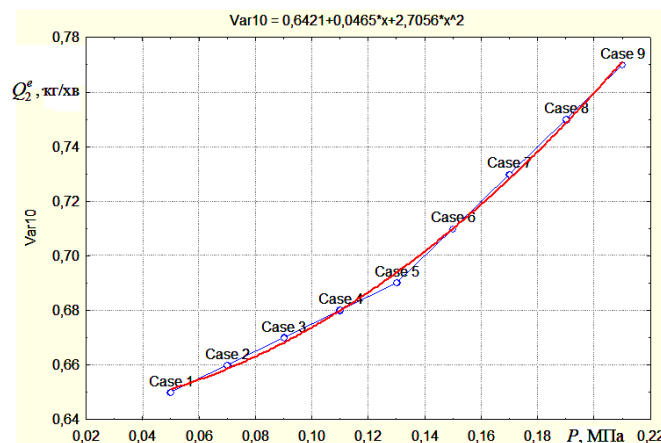

Fig. 5 - Dependence of efficiency as a functional on air pressure $P = (0.5...0.21) \cdot 10^6$ N/m²

The general view of the regression equation, which describes the dependence of pilot plant efficiency Q_1^e at high pressure air feed on the area of a discharge hopper hole S_c , the frequency of screw rotation n and operating pressure P based on the results of the conducted multi-factor experiment in actual values is the following:

$$Q_2^e = -25.23 + 7.34 \ln(S_c) + 2.26 \ln(n) + 2.97 \ln(P). \quad (3)$$

During the performance of the experiments, the factorial field was determined by the following parameter range: $12 \leq S_c \leq 35$ (10^{-4} m²); $150 \leq n \leq 450$ (rev/m); $0.2 \leq P \leq 0.5$ (10^6 N/m²).

Based on the regression equation (3), a response surface with its two-dimensional section of the change in the pilot plant efficiency Q_2^e at high-pressure air feed as a functional $Q_2^e = f(S_c, P)$ and $Q_2^e = f(n, P)$ at constant values of the relevant third factor, that is to say at $x_2 = n = \text{const}$, $x_1 = S_c = \text{const}$ was constructed. Graphical dependences of functional $Q_2^e = f(S_c, P)$ and $Q_2^e = f(n, P)$ are represented in Fig. 6 and Fig. 7.

It has been determined that efficiency Q_2^e increases with the increase of operative factors and is within the limits of 2...11 kg/s depending on their change. The frequency of screw rotation n and the area of a hopper discharge hole S have the most significant influence on the pattern of efficiency Q_2^e change, namely, a significant increase of Q_2^e is observed at the increase of the relevant factor value $S_c \geq 24 \cdot 10^{-4}$ m², $n \geq 300$ rev/m. In addition, it has been determined that depending on the change of operating air pressure P within the limits of factor change $0.2 \leq P \leq 0.3$ (10^6 N/m²), the efficiency of a pneumatic screw conveyor increases rectilinear to the increase of P , here, the gain is about 1.1 kg/m.

The disadvantage of such additional feeding is that air streams, which are coming out of pneumatic system nozzles and directed into a transportation flow, are placed at a high angle. Such arrangement of nozzles is inconsistent with the direction of material movement in a flexible pipe.

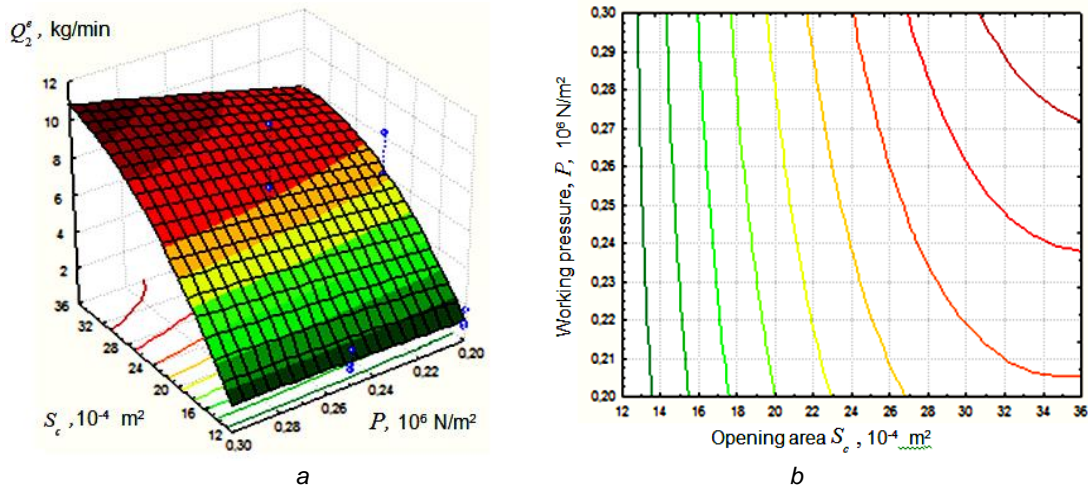

Fig. 6 - A response surface (a) and its two-dimensional section (b) of the pneumatic screw conveyor efficiency as a functional $Q_n = f(S_c, P)$ at $n = 300 \text{ rev/m}$

The construction arrangement and the general view of a new technical performance of the pneumatic screw conveyor are represented in Fig. 8. It consists of carriage 1 and 2, where there is a drive 3, a frame 4 with a hopper 5, a screw feeder 6, a pneumatic system 7 and a pneumatic valve 8 arranged. A conveyor pipeline consists of series-connected sections 9 of length l , here, each section contains an elastic casing 10, which, on its right side, is fixed on a coupling cylinder bushing 11 with the help of a ring 12 that is regulated by bolt 13 tightening.

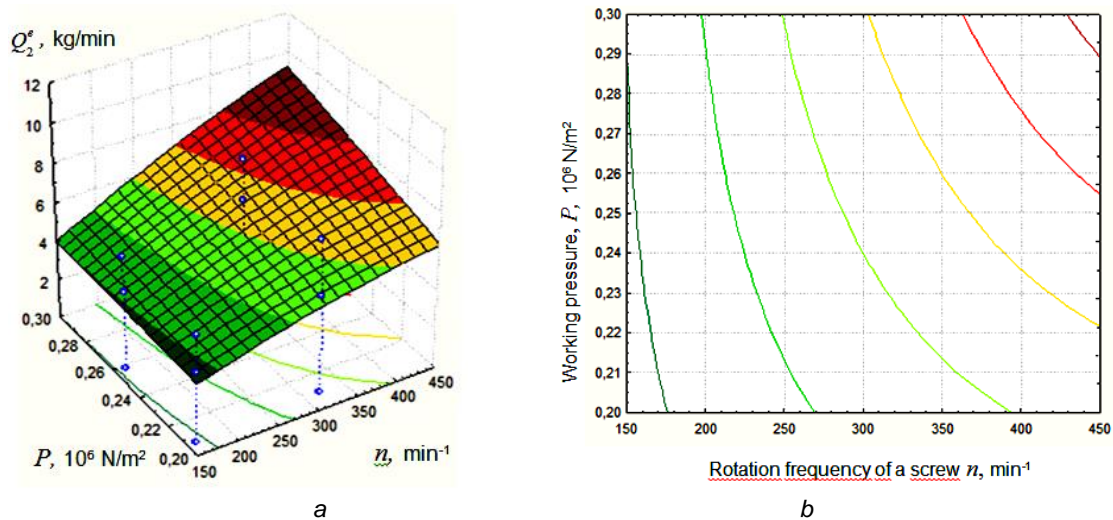

Fig. 7 - Response surface (a) and its two-dimensional section (b) of the pneumatic screw conveyor efficiency as a functional $Q_n = f(n, P)$ at $S_c = 24 \cdot \text{m}^2$

In the central part of a cylindrical bushing 11 there are openings 14 inclined in the direction of material transportation, which are arranged in a circle and are caught by a Π -shaped bushing 15, on the outer diameter of which there are connectors 16 arranged at an angle in the direction of material transportation and to which there are air supply hoses 17 attached. On the left side of an elastic casing on air supply hoses there are inlet connectors 18 arranged, which are connected to the common pneumatic system of the conveyor, here, the length of air supply hoses of every next section are twice bigger than those of the previous one and the hoses of the section are displaced in circular direction and fixed along the section length 9 by a clamp 19.

While in operation, the material comes through a hopper 5 into a conveyor body 4 on a screw feeder 6. When there is overload caused by the accumulation of a certain amount of loose material in the processing chamber of the conveyor body 4, a screw feeder is displaced axially in the direction opposite to material transportation. Here, air comes along hoses 17 through holes 14 into the section 9 and dilutes the accumulated material.

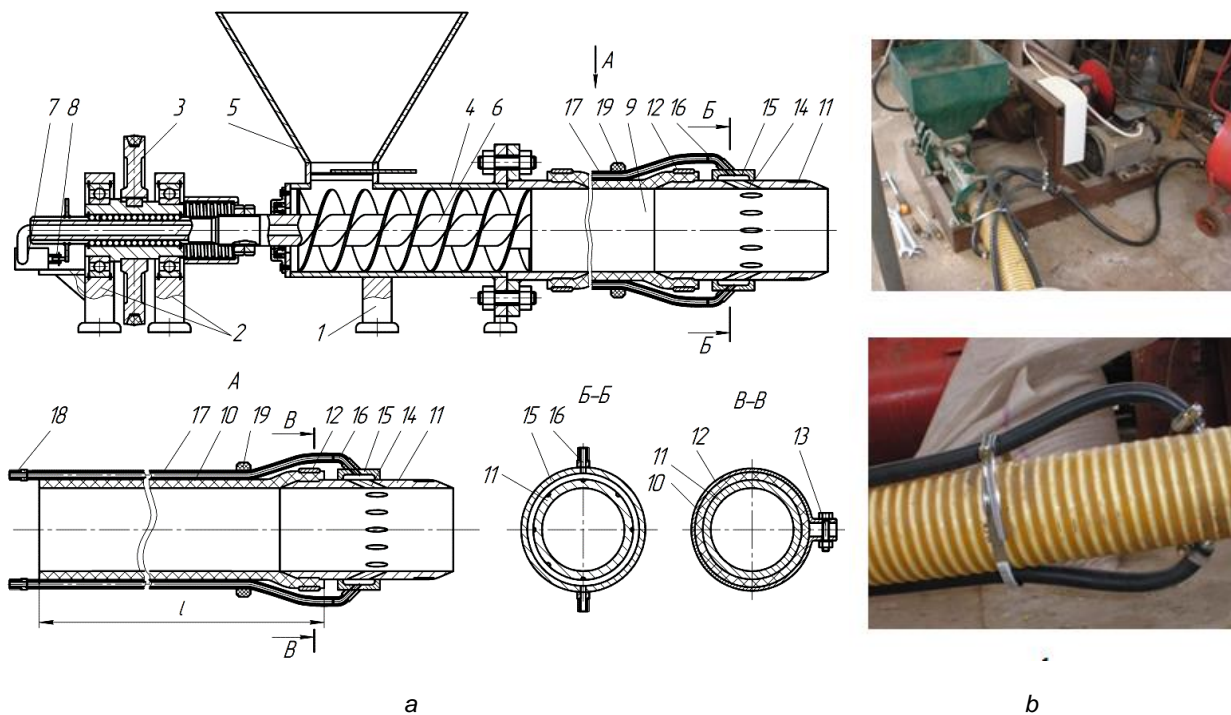

Fig. 8 - Construction arrangement (a) and general view (b) of the pneumatic screw conveyor with feeding hoses connected to a flexible casing

CONCLUSIONS

The paper presents the developed design of a pneumatic screw conveyor and investigation procedure for determining the dependence of pneumatic screw conveyor efficiency on the change in the form and the geometrical parameters of a nozzle, the area of hopper hole, the frequency of screw feeder rotation and the value of operating air pressure in a technological lane.

Response surfaces and their two-dimensional sections have been constructed and their analysis shows that the efficiency Q_n of a pneumatic screw conveyor increases with the increase of the operating factors and is within the limits of 2...11 kg/s.

The frequency of screw rotation n and the area of a hopper discharge hole S_c have the most significant influence on the pattern of efficiency Q_n change, namely, there is significant increase of Q_n with the increase of the relevant factors value $S_c \geq 24 \cdot 10^{-4} \text{ m}^2$ and $n \geq 300 \text{ rev/m}$.

Based on the results of the conducted investigations, a pneumatic screw conveyor with additional feeding of material flow by means of air streams has been developed and made.

REFERENCES

- [1] Hevko R.B., Dzyura V.O., Romanovsky R.M., (2014), Mathematical model of the pneumatic-screw conveyor screw mechanism operation, *INMATEH: Agricultural Engineering*, vol.44, no.3, pp.103-110, Bucharest / Romania;
- [2] Lech M. (2001) - Mass flow rate measurement in vertical pneumatic conveying of solid, *Powder Technology*, Vol.114, Issues 1-3, pp. 55-58;
- [3] Manjula E.V.P.J., Hiromi W.K. Ariyaratne, Ratnayake Chandana, Morten C. Melaaen (2017) - A review of CFD modelling studies on pneumatic conveying and challenges in modelling offshore drill cuttings transport, *Powder Technology*, vol.305, pp. 782-793;
- [4] Naveen Tripathi, Atul Sharma, S.S. Mallick, P.W. Wypych (2015) - Energy loss at bends in the pneumatic conveying of fly ash, *Particuology*, vol.21, pp. 65-73;
- [5] Hevko R.B., Klendiy M.B., Klendii O.M., (2016), Investigation of a transfer branch of a flexible screw conveyor, *INMATEH: Agricultural Engineering*, vol.48. no.1, pp.29-34, Bucharest / Romania;
- [6] Hevko R.B., Rozum R.I., Klendiy O.M. (2016), Development of design and investigation of operation processes of loading pipes of screw conveyors, *INMATEH: Agricultural Engineering*, vol.50, no.3, pp.89-96, Bucharest / Romania;

- [7] Hevko R., Vitrovyi A., Klendii O., Liubezna I., (2017), Design engineering and substantiation of the parameters of sectional tools of flexible screw conveyors, *Bulletin of the Transilvania University of Brasov*, Vol. 10(59), pp. 39-46, Brasov / Romania;
- [8] Hevko R.B., Yazlyuk B.O., Liubin M.V., Tokarchuk O.A., Klendii O.M., Pankiv V.R., (2017), Feasibility study of the process of transportation and stirring of mixture in continuous-flow conveyors, *INMATEH: Agricultural Engineering*, vol.51, no.1, pp.10-20, Bucharest / Romania;
- [9] Loveikin V., Rogatynska L., (2011), A Model of Loose Material Transportation by Means of High-Speed Conveyors with Elastic Operating Devices (Модель транспортування сипкого вантажу швидкохідними гвинтовими конвеєрами з еластичними робочими органами). *Bulletin of the Ternopil Ivan Puluj National Technical University (Вісник Тернопільського національного технічного університету ім. І.Пулля)*, vol.16, pp.66-70, Ternopil / Ukraine;
- [10] Lyashuk O.L., Rogatynska O.R., Serilko D.L., (2015), Modelling of the vertical screw conveyor loading, *INMATEH Agricultural Engineering*, vol.45, no.1, pp.87-94, Bucharest / Romania;
- [11] Rogatynska O., Liashuk O., Peleshok T., Liubachivskyi R., (2015), Investigation of the Process of Loose Material Transportation by Means of Inclined Screw Conveyors (Дослідження процесу транспортування сипкого вантажу похилими гвинтовими конвеєрами), *Bulletin of the Ternopil Ivan Puluj National Technical University (Вісник Тернопільського національного технічного університету ім. І.Пулля)*, vol.79, pp.137-143, Ternopil / Ukraine.